

RECINZIONE DI CONFINE

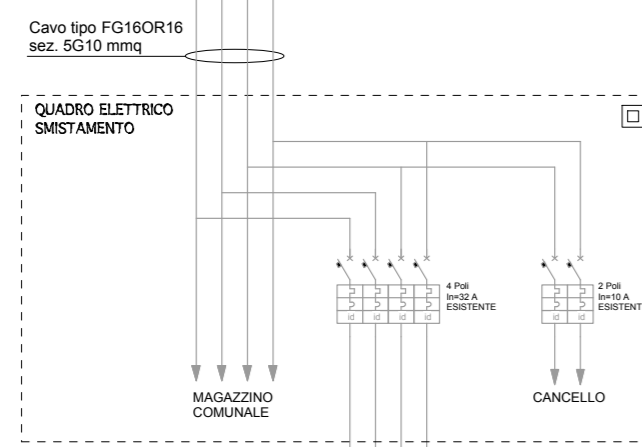

EDIFICIO PROTEZIONE CIVILE

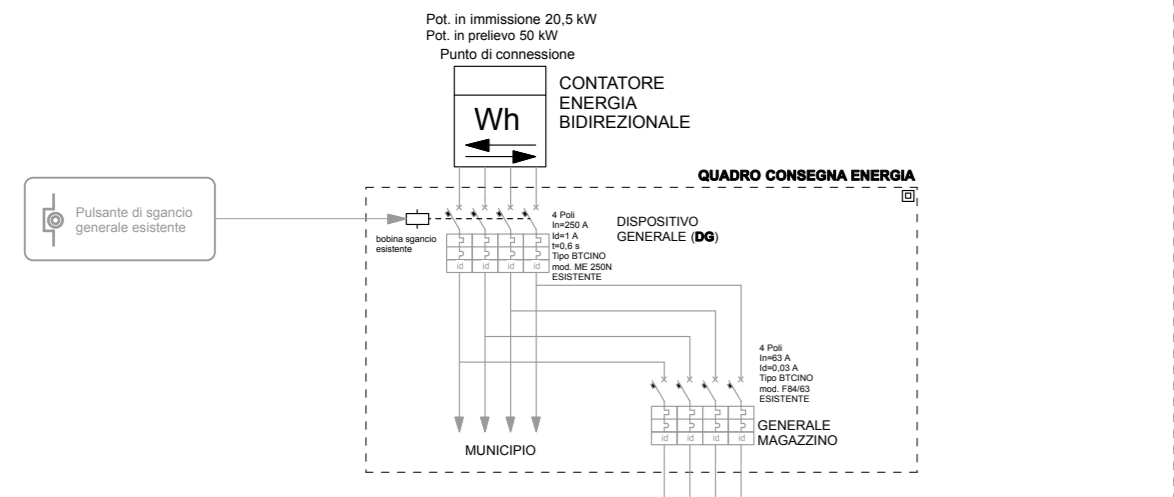
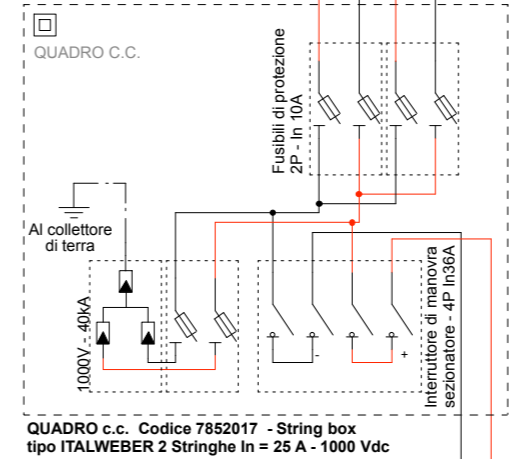
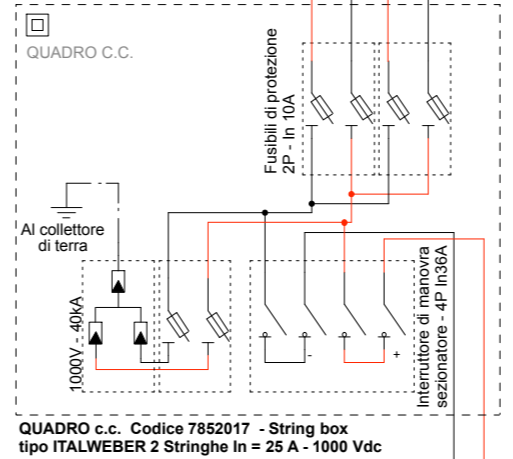
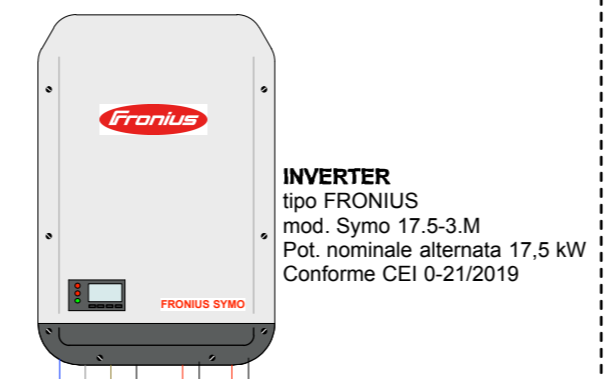
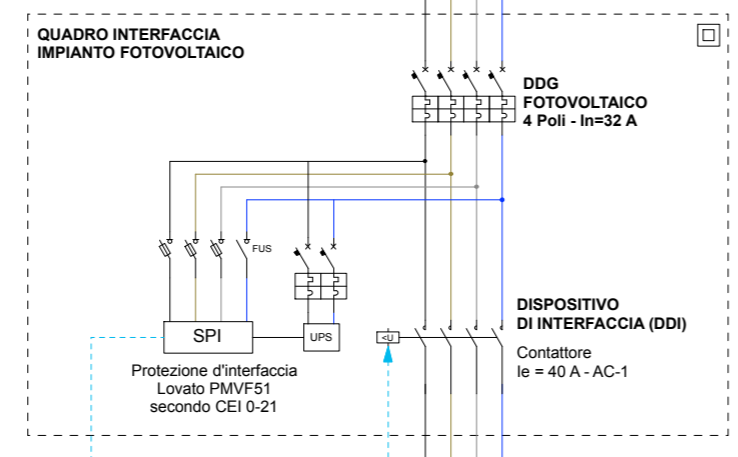
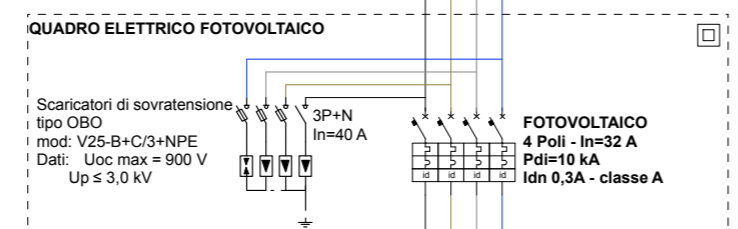
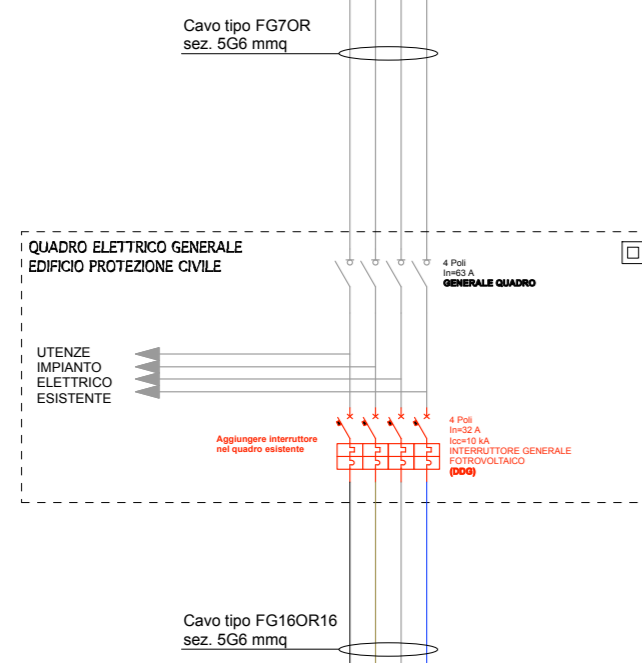

COPERTURA EDIFICIO
POTENZA TOTALE IMPIANTO FOTOVOLTAICO: 18,42 kWp

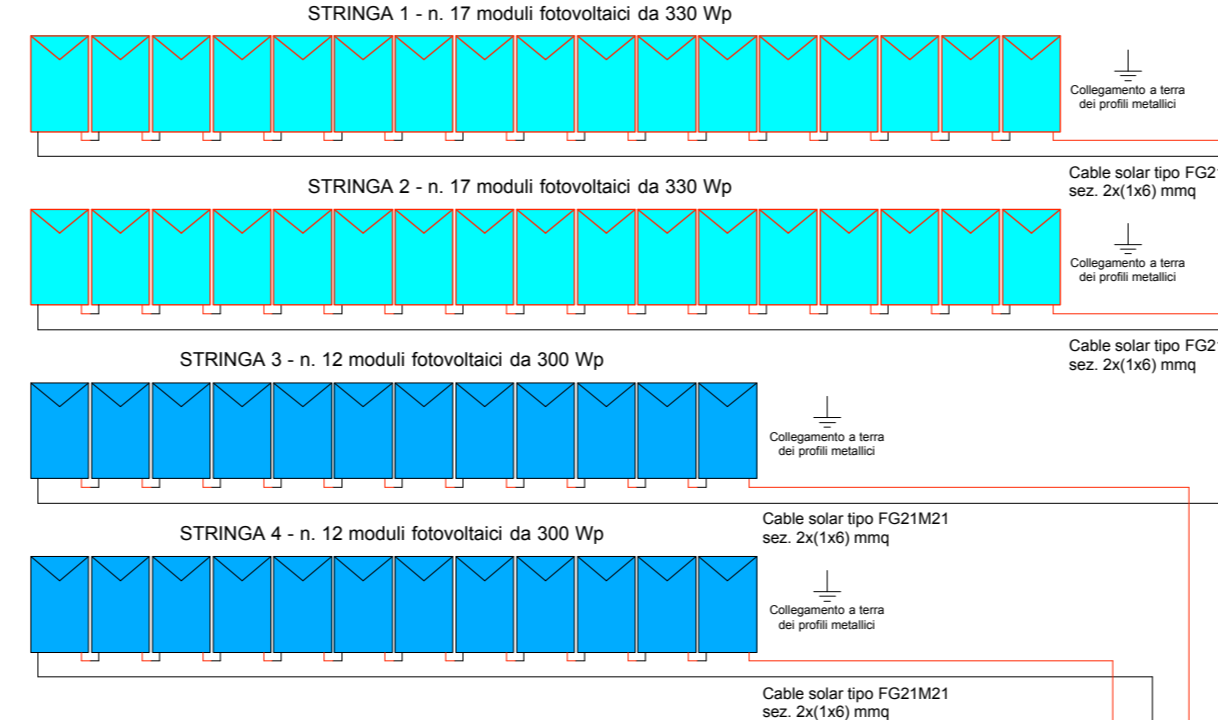

COMUNE DI TALMASSONS PROVINCIA DI UDINE

IMPIANTO FOTOVOLTAICO
AREA MUNICIPIO

Ubicazione edificio: Via Tomadini, 15

Titolo:

PROGETTO: IMPIANTO FOTOVOLTAICO

Disegno:

SCHEMA ELETTRICO

Tavola numero:	N° rev	Data	Aggiornamento
E 2	0	05/09/19	Emissione
	1	--/--	-
	2	--/--	-
	3	--/--	-

Committente: **COMUNE DI TALMASSONS**
Via Tomadini, 15 - 33030 - Talmassons (UD)
P. IVA 00544040306 - C.F. 80010190306

Il tecnico:

VUARAN Per. Ind. Massimiliano

VB STUDIO TECNICO ASSOCIATO
dei per.ind. Massimiliano VUARAN & Fabio BENEDETTI

Ufficio: Via Gen. Radaelli, N° 43 - 33053 - LATISANA (UD)
Telefono 0431-50568 e-mail 043150568@iol.it

Latisana, 05/09/2019